



Features & Benefits

- Quick fit optics customize the light beam to deliver optimum performance
- Plug & play
- Unique waterproofing concept – instant IP65 rating for the light engines
- Protective UV stabilised powder coated finish
- Compatible with multiple dimming protocols including 0-10v & DALI
- Optional built-in emergency
- 0% ULOR – a great choice for Dark Sky applications

Application

MFL flood lights are ideal for;

- Building facades
- Area lighting
- Signage & billboards
- Specialist Sport lighting
- Depots
- Heavy industrial & wet location

Product Family Name:	MFL Modular Floodlight Floodlight	Input Voltage:	100-305V
Product Family Code:	MFL>See options below<	Input Frequency:	50-60Hz
LED Brand:	LUMILEDS or OSRAM	Control Signal:	0-10v / DALI Optional
LED Colour Temp:	2700-3000-4000-5000-6500K	Chassis Material:	Die-Cast Aluminium
CRI:	70 (80 available)	Chassis Colour:	Black
Light Source Replaceable:	YES	Optical Cover/lens:	Polycarbonate
Power Supply:	Intergrated	Mechanical Accessories:	NA
Optical Distribution:	Round: D2, D3, D6 Area: Type I, Type II, Type III, Type IV, Type V	Weight:	On request
Optical Cover/Lens:	Polycarbonate	System Power:	30w to 1200w
Dimmable:	OPTIONAL	Luminous flux:	4,080 to 208,000 Lm
Photocell:	OPTIONAL	LED Luminaire efficacy:	123-166 Lm/W
Power Cable:	Bracket mounted junction box for power connection.	Power Factor:	>0.9
IP Rating:	IP65	Working Temp:	-40° to +40°C
Mounting:	Stirrup Bracket	Lifetime:	>50,000hrs (>100,000hrs with EUM driver)
Aiming Angles:	0° to 180°	Certification:	CE
UMSUG:	Available	Warranty:	5 years

Dimensions, Weights & *windage if mounted facing the ground

30 / 50 / 75 / 100

4kg / *0.04m²

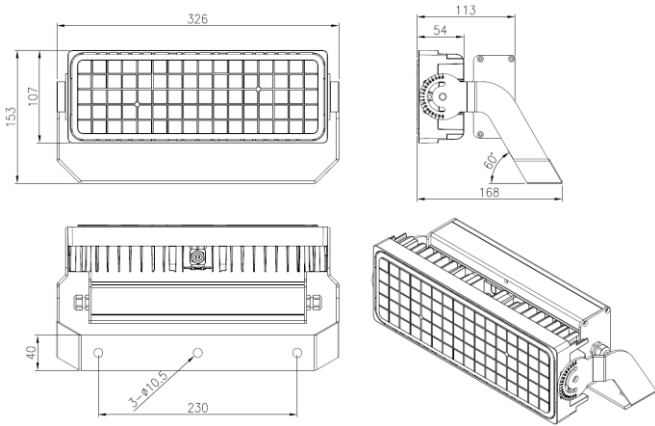

150 / 200

6.8kg / *0.045m²

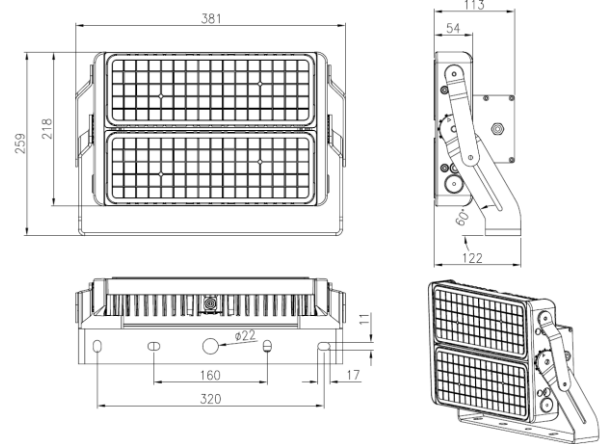

300

8.8kg / *0.045m²

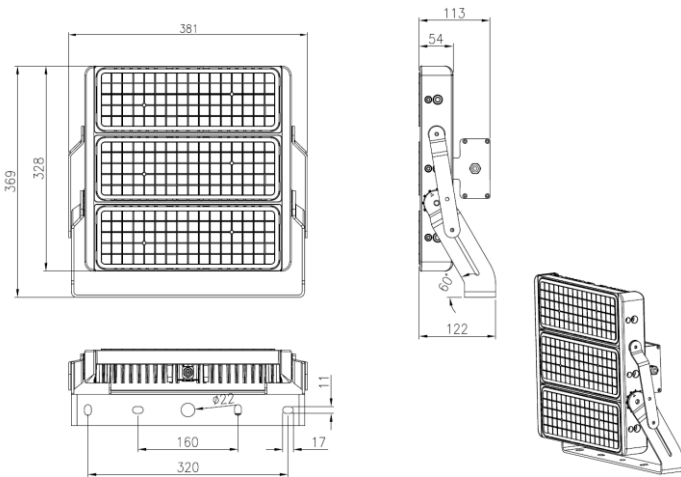

400

11.8kg / *0.055m²

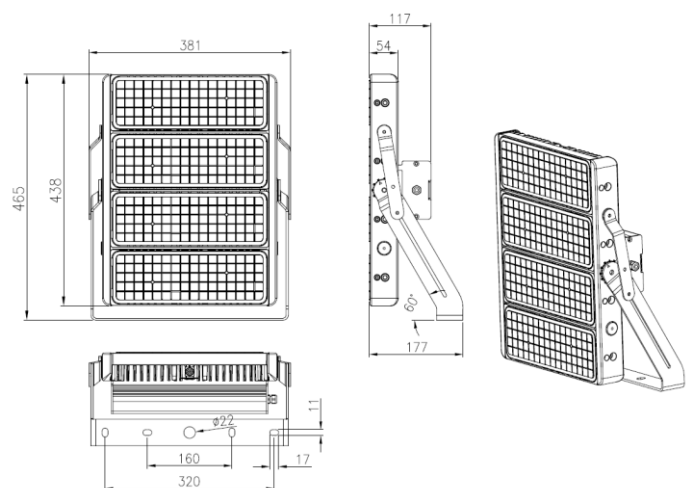

500

14kg / *0.07m²

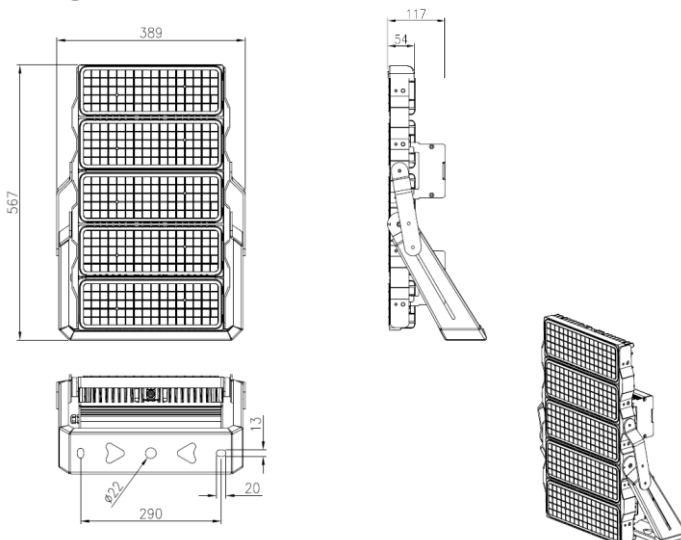

600

16.8kg / *0.07m²

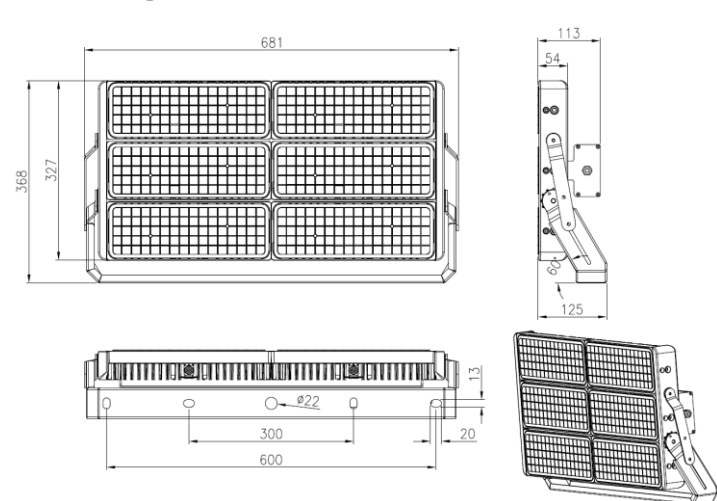

800

21kg / *0.085m²

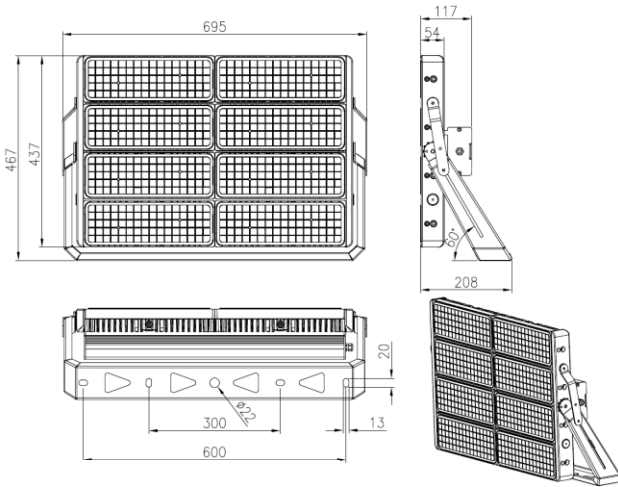

1000

30kg / *0.08m²

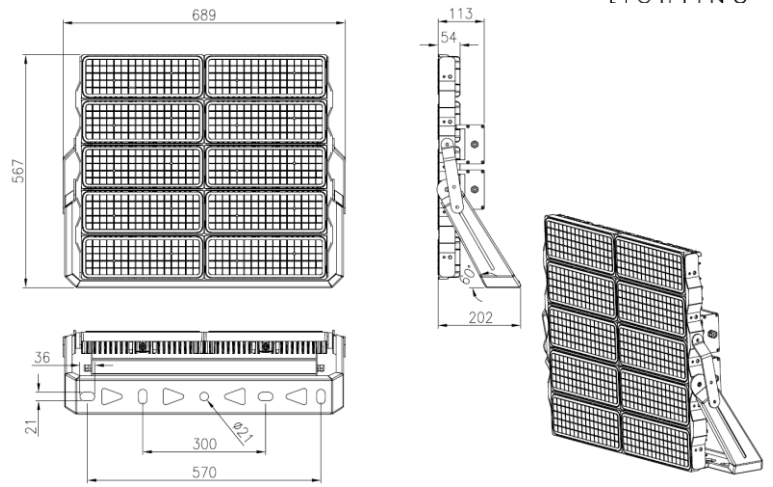

1200

35kg / *0.08m²

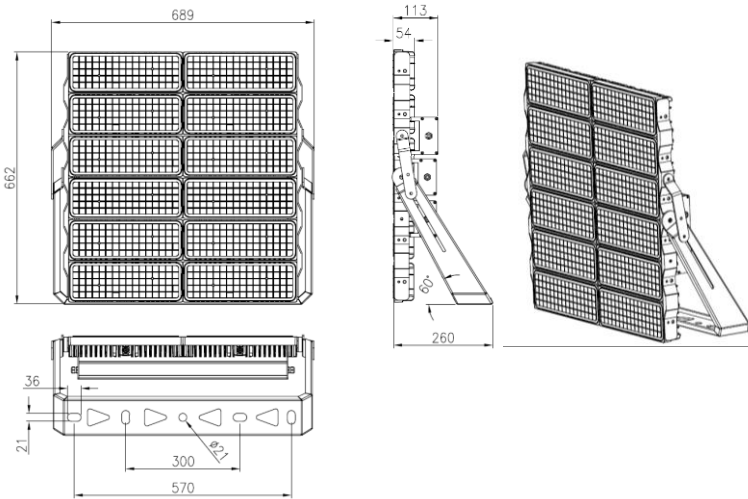

Photometrics

D2

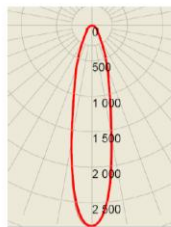

20°x20°
Very-Narrow beam

D3

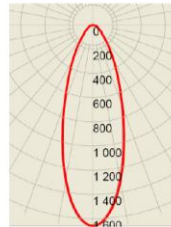

30°x30°
Narrow beam

D6

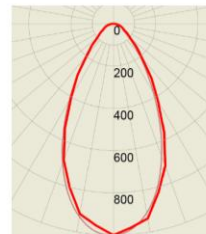

60°x60°
Medium beam

T1

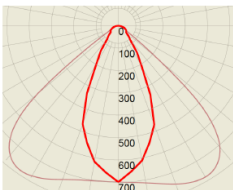

Type I
(30°x100°)

T2

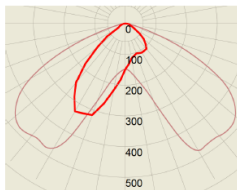

Type II
(50°x140°)

T3

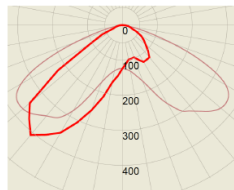

Type III
(40°x140°)

T4

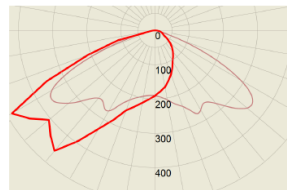

Type IV
(30°x140°)

T5

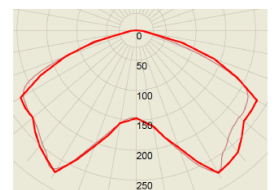

Type V
(140°x140°)

Ordering Information

Product ID	System Power	Colour Temp	CRI	Optics	Control	Finish
MFL	30 = 33W 50 = 55W 75 = 82W 100 = 110W 150 = 160W 200 = 220W 300 = 320W 400 = 440W 500 = 550w 600 = 620W 800 = 880W 1000 = 1100W 1200 = 1280W	27K = 2700K 30K = 3000K 40K = 4000K 50K = 5000K 65K = 6500K	70 = Min 70 80 = Min 80	D2 = Round (20°×20°) D3 = Round (30°×30°) D6 = Round (60°×60°) T1 = Type I (30°×100°) T2 = Type II (50°×140°) T3 = Type III (40°×140°) T4 = Type IV (30°×140°) T5 = Type V (140°×140°)	ND = Non-Dimmable VD = 0-10V Dimmable DD = DALI Dimmable	BL = Black (as standard) WH = White
Example ordering code: MFL 30 27K 70 D2 ND BL						

Please note: actual performance may differ as a result of end-user environment and application. All values are typical values, measured under laboratory conditions at 25 °C. Specifications subject to change without notice.