

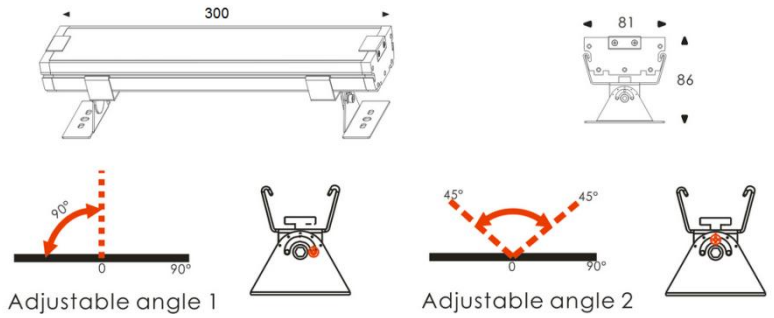

Canon Colour – Linear Series

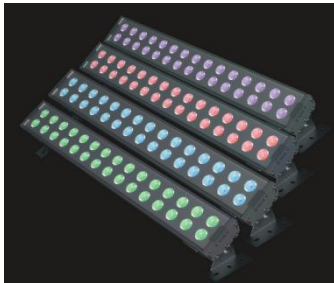

Low Voltage Input (24VDC) power cord

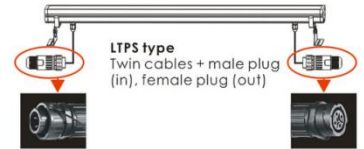
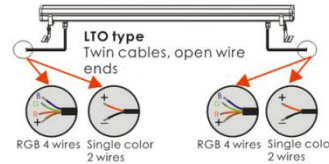
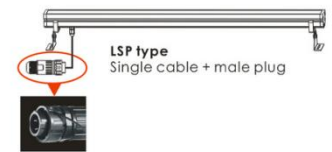
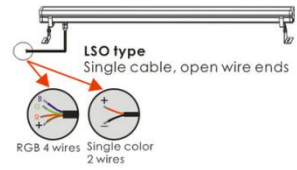

High Voltage Input (100V-240V) power cord

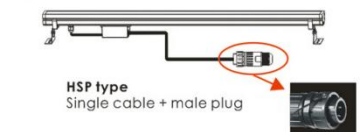
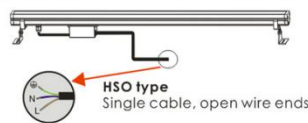

| | |
|------------------------------|--|
| Product Family Name: | Canon Colour - Linear Series |
| Product Family Code: | CPL-FL-NB->Colour<-30 |
| LED Brand: | Osram |
| LED Colour Temp: | RGB or single Colour |
| CRI: | n/a |
| Power Supply: | LV-Separate or Mains - Integrated optional |
| Optical Type: | Spot 20° |
| Optical Distribution: | Single Spot |
| Optical Cover/Lens: | PMMA |
| Dimmable: | Optional |
| Photocell: | n/a |
| Power Cable: | 0.5m HO5RN-F 3x1mm ² |
| IP Rating: | IP65 |
| Mounting: | Stirrup bracket with aiming |

| | |
|--------------------------------|------------------------------------|
| Input Voltage: | LV = 24vDC Mains = 100-240V |
| Control Signal: | n/a (Set by driver for LV version) |
| Chassis Material: | Powder Coated Die-cast Aluminium |
| Chassis Colour: | Grey |
| Optical Cover/lens: | 4mm Tempered Glass |
| Options: | n/a |
| Mechanical Accessories: | Bracket included |
| Weight (Kg): | 4 |
| System Power (w): | 28w |
| IK: | 5 |
| Working Temp: | -20° to +40°C |